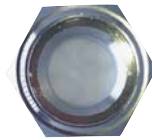

Flush Diaphragm Pressure Transmitter

Model : P510 Series(Ceramic Diaphragm)
P520 Series(Stainless steel)

WISE
SENSOR

Advantages

- Flush diaphragm with ceramic or stainless steel
- Shock and vibration resistant
- Zero and span adjustments
- Measuring ranges
 - P510 Series : 0.5~50 kgf / cm²
 - P520 Series : 0.1~35 kgf / cm²



P510 Series



P515 / P525



P516 / P526

Applications

The transmitters are specially designed for pressure measurement in sticky, high viscous liquids.

- Process control for food and beverage industry
- Tank level measurement
- Chemical and petrochemical industry
- Equipment and machinery for paint, ink, resin and dough process
- Cosmetic and pulp industry
- Pharmaceuticals

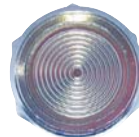

P520 Series



P517 / P527



P518 / P528

Descriptions

Flush mounted pressure transmitters are perfectly suitable for measuring static pressure in sticky and high viscous liquids in industrial applications. They incorporate a fully temperature compensated piezoresistive ceramic or silicon sensor which is corrosion resistant, and a strong, durable flush mounted diaphragm. The transmitters are available as absolute and relative pressure types with either 2-wire current or 3-wire voltage output. The versatile process connections including thread, flange and clamp mounting are available by customer requirement.

The pressure to be measured acts without transmitting liquid on a stable, corrosion resistant ceramic or silicon measuring cell. Piezoresistive resistors are attached to the cell and connected into a Wheatstone bridge configuration. The output signal of this bridge is converted into a standardized current or voltage output signal.

Specification

Input		
Model	P510 Series	P520 Series
Technology	Piezoresistive ceramic pressure sensor	Piezoresistive silicon pressure sensor
Pressure ranges	0~0.5 to 50 kgf / cm ² relative	0~0.1 to 0~35 kgf / cm ² relative
	0~1 to 50 kgf / cm ² absolute	0~1 to 35 kgf / cm ² absolute
Pressure reference	vacuum Gauge, absolute compound	
Overload	1.5x full scale without damage	3x full scale without damage
Output		
Unamplified	2.0~3.3m V / V	5.0m V / V
Amplified	4~20mA current (2-wire)	
	1~5V voltage (3 or 4-wire)	
	Other signals available on request	
Electrical Specification		
Excitation voltage	24V DC (12~36V DC)	
Load resistance max @ 24V	500Ω at 24V	
Influence of excitation	0.01% FSO / V	
Power ripple	≤ 500mV P-P	
Reverse polarity	Protected	
Shock resistance	≤ 20g	≤ 10g
Response time (10~90%)	1.5 ms	≤ 2 milliseconds
Adjustment	± 10% FSO / zero and span	
Performance Specification		
Accuracy	≤± 0.5% FSO	≤± 0.25% FSO
Linearity,Hysteresis & Repeatability	± 0.2~0.4% FSO typical	± 0.05% FSO typical
Stability	± 0.3% FSO / a@25°C	± 0.15% FSO / a@25°C
Cutoff frequency(-3 d B)	≤ 2KHz	
Reference temperature	25°C	35°C
Operating temperature range	-40~125°C	-40~125°C
Compensated temperature range	0~70°C	0~82°C
Thermal sensitivity shift	≤± 0.015% / °C typical	≤± 0.05% FSO typical
Thermal zero shift	≤± 0.02% FSO / °C typical	≤± 0.1% FSO typical
Physical Specification		
Process connection	PF3/4, male thread as a standard	
	Other connections available on request	
Process media	Gases and liquids compatible with	
Materials of Diaphragm	Stainless steel 316L	
Housing	Stainless steel 316	
Gasket O-ring	Viton, HNBR, Teflon	
Enclosure rating	IP65	
Influence of mounting position	Not critical	Under 0.5 kgf / cm ² , mounting vertically
Weight	Approx. (157g)	

Note : ① Cable version : 1.5m standard length, 4-wire, shielded with integral vent tube

② Vented gauge units must breathe dry, non - corrosive gases.

③ Connector version is vented through the removed pin, cable versions are vented through a vent tube inside the cable sleeve

System connection for 2-wire transmitter

System connection for 3-wire transmitter

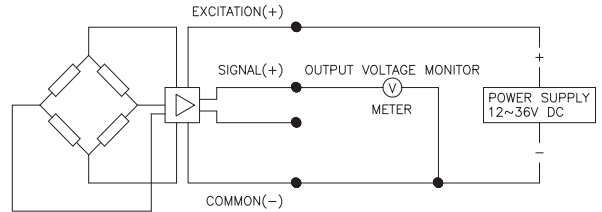
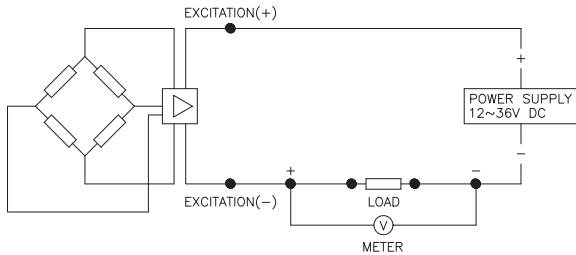

Dimension (mm)

Electrical connection

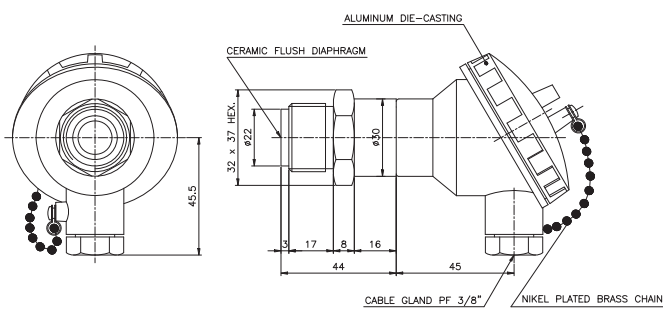
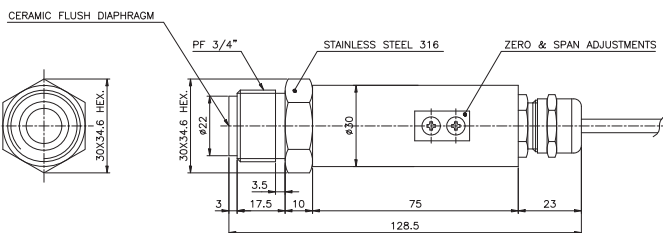
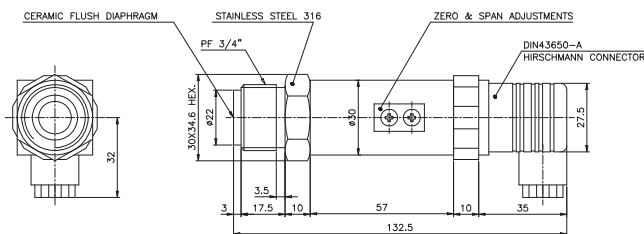
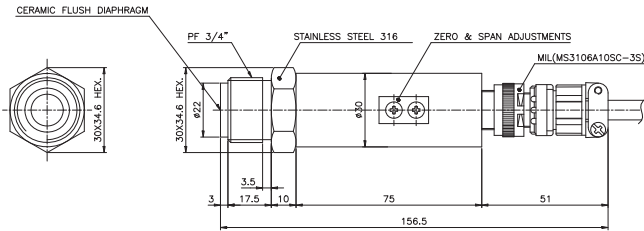

E : Excitation
S : Signal
C : Common

Circular connector

System Color	2-Wire	3-Wire	4-Wire
Red	E +	E +	E +
Black	E -	C -	E -
Green		S +	S +
White			S -
GND	Shielded	Shielded	Shielded

DIN connector

System Color	2-Wire	3-Wire	4-Wire
1	E +	E +	E +
2	E -	C -	E -
3		S +	S +
GND	Shielded	Shielded	S -

Flying Lead

System Color	2-Wire	3-Wire	4-Wire
Red	E +	E +	E +
Black	E -	C -	E -
Green		S +	S +
White			S -
GND	Shielded	Shielded	Shielded

General head

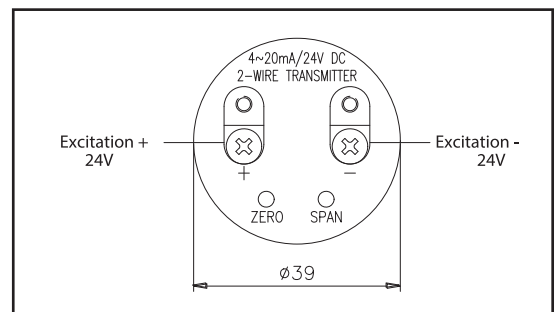

Ordering Information

Flush Diaphragm Pressure Transmitter

1. Base model

P515										Ceramic Diaphragm	Circular Connector
P525										Stainless Steel Diaphragm	
P516										Ceramic Diaphragm	DIN Connector
P526										Stainless Steel Diaphragm	
P517										Ceramic Diaphragm	Flying Lead
P527										Stainless Steel Diaphragm	
P518										Ceramic Diaphragm	General Head
P528										Stainless Steel Diaphragm	

2. Pressure reference

R										Relative pressure
A										Absolute pressure

3. Process connection type "1"

M										Male thread
F										Female thread

4. Process connection type "2"

T										PT thread as standard
F										PF thread
X										Other process connections available on request

5. Process connection size

1										3/4 (standard)
2										1"
X										Other units available on request

6. Accuracy

H										± 0.25% F.S.O (with silicon cell)
S										± 0.5% F.S.O (with ceramic cell)

7. Measuring range

01										0~2000 mmH ₂ O (Only available P520 series)	
02										0~3000 mmH ₂ O (Only available P520 series)	
03										0~5000 mmH ₂ O	
04										0~1 kgf / cm ² , bar	0~0.1 Mpa
05										0~2 kgf / cm ² , bar	0~0.2 Mpa
06										0~5 kgf / cm ² , bar	0~0.5 Mpa
07										0~20 kgf / cm ² , bar	0~2 Mpa
08										0~35 kgf / cm ² , bar	0~3.5 Mpa
09										0~50 kgf / cm ² , bar, bar (Only available P510 series)	0~5 MPa (Only available P510 series)
xx										Other calibration ranges available on request	

8. Unit

K										Calibration in kgf / cm ²
A										Calibration in Mpa
B										Calibration in bar
X										Other units available on request

9. Output signal / Electrical connection type

A1										4~20mA, DC, 2-wire output
A2										4~20mA, DC, 4-wire output
B1										1~5V, DC, 3-wire output
B2										0~5V, DC, 3-wire output (Only available P516, P526, P517 and P527)
B3										0~10V, DC, 3-wire output (Only available P516, P526, P517 and P527)

10. Option

N										None options
X										Other accessories available on request

P526	R	M	F	1	S	01	K	A1	N	Sample ordering code
------	---	---	---	---	---	----	---	----	---	----------------------

Specifications subject to change without notice